

Close Vehicle Warning for Bicyclists based on FMCW radar

Tomas Krejci, Michal Mandlik
Faculty of Electrical Engineering and Informatics
University of Pardubice
Pardubice, the Czech Republic
tomas.krejci2@student.upce.cz, michal.mandlik@upce.cz

Abstract— The aim of this article is to show the concept of the close vehicle warning based on Frequency Modulated Continuous Wave (FMCW) radar. The radar works at frequency 24.1 GHz with 180 MHz bandwidth and it is intended to detect cars behind a bicyclist. The implementation of the signal processing is tested in the simulation and it is realized in Field Programmable Gate Array System On Chip and with low-cost FMCW radar. The system is installed on the bicycle.

Keywords— FMCW; radar; bicycle; active safety

I. INTRODUCTION

Higher public transportation in cities made people to think about security connected with this issue. Cars, trucks and motorcycles are commonly equipped by sensors which mostly cover 360° of the field view and help them to make public transport safe. The car industry goes ahead to make a public transport safer and safer with an attention to fulfill more and more strict Euro NCAP scenarios. The goal of car makers is to make cars which could be driven automatically or at least autonomously soon. Cars are equipped with different types of sensor, from ultrasonic sensors, camera sensors to radar and lidar (laser) sensors. However, less attention is focused on bicyclists, the most imperiled users on public roads, especially in cities. Bicyclists could be protected using the cutting-edge technologies as well. Whether bicyclists are informed about an oncoming car behind them, they can react more in advance and the chance that they can avoid the incident is higher. The field of applications is widely opened for new innovations. For instance, Garmin is one of the pioneers in this sphere [1] and uses a radar system as the technology which could help and

improve bicyclist transportation. The radar requirements are low price, ability to work in bad weather conditions and at night [2], [3].

This paper summarizes our proposal of Frequency Modulated Continuous Wave radar for bicyclists. Our proposed solution should deal with good estimation in range and velocity; the added value shall be estimation in angle. The radar works in the K-band. The K-band is widely used in automotive industry, as well as it is widely available on the market. The main feature of the designed system is to provide the alerts (visual and audible) via wireless interface to a cell phone. The mobile phone shall be used as an interface in the order to make a final design cheaper.

The system must deal with common traffic situations in a city environment. The operation range shall be from 0.5 m up to 50 m. The maximum of velocity ambiguity of the target shall be 25 m/s. This criterion is enough for most of the situations in a city. Resolution in the range shall be less than 1 m and the resolution in the Doppler velocity shall not exceed 1 m/s. It would be suitable as the first criteria for the system design proposal. The block scheme of the system is described in Fig. 1.

The green dashes part covers the analog front-end of the system and the red dashes part covers the digital part of the proposed system. FMCW radar is similar to Doppler radar because it is based on measuring velocity using Doppler Effect, but it has the benefit. The benefit is measuring distances of objects.

FMCW radar is able to measure distances of static objects using Frequency shift of transmission and reception signal.

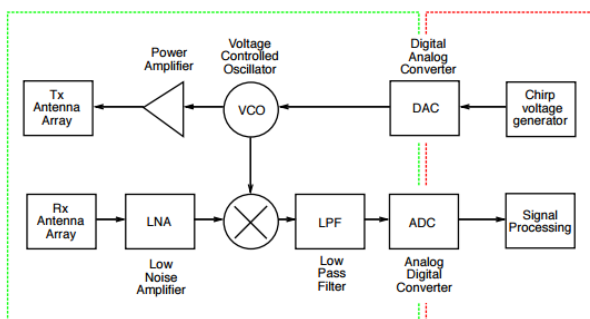

Fig. 1. Block scheme of FMCW radar.

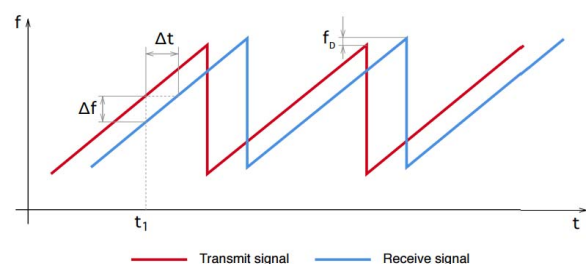

Fig. 2. Saw tooth waveform design.

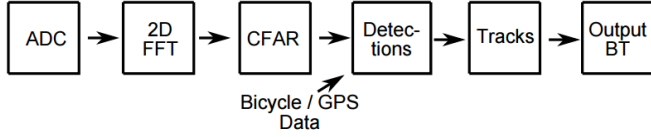

Fig. 3. Block scheme signal processing of FMCW radar.

The measurement of distance is based on frequency modulation. A random signal can be used as a modulation signal, but commonly used signals are a saw tooth, a triangle or a sinusoidal signal. A saw tooth signal was chosen for our design (shown in Fig. 2). Signal processing pipeline is shown on the Fig. 3.

There are few potential issues which need to be solved, e.g. bicyclists are moving, as well as the sensor mounted on a bike. The velocities of detections have to be compensated in Range-Doppler spectrum by velocity of the bicyclist and need to be identify as static or moving targets. Information about the velocity of the bicyclist is provided to the cell phone via Bluetooth [4], [5], [6].

II. SYSTEM DESIGN

First of all, it is needed to consider some parameters. The maximum radius of the radar system shall be 50 m; the maximum distance in the city and the maximum relative speed 10 m/s gives 5 s for the application provides the alert. The maximum clock rate for Analog-Digital Converter (ADC) is 1 MSps. The formula (1) defines the maximum range ambiguous range.

$$R_{\max} = \frac{F_s}{2} \cdot \frac{T_{\text{chirp}} \cdot c}{2 \cdot BW}, \quad (1)$$

where, R_{\max} is the maximal range, F_s is the sampling frequency, T_{chirp} is the time interval for one chirp (saw tooth) and BW (bandwidth) is a difference between minimum and maximum frequency. The sampling rate of ADC is 1 MSps. Time of T_{chirp} is set to value 11.5 ms due to requirement of R_{\max} . Maximal effective bandwidth of the radar sensor is 180 MHz. [13] In that case the maximum distance is at 47.96 m. The resolution in the range is derived by the same formula (1) but instead of sampling frequency F_s is considered the resolution of Fourier Transform. Size of one-dimensional FFT is 256 samples. In our case Δf (2) is 3.906 Hz and ΔR (3) is 0.373 m which is two times more accurate than the limitation due to BW .

$$\Delta f = \frac{F_s}{N_{\text{FFT}}} \quad (2)$$

$$\Delta R = \frac{\Delta f \cdot T_{\text{chirp}} \cdot c}{2 \cdot BW} \quad (3)$$

The next step in system design development is to know what is the velocity resolution and the maximal ambiguous in velocity, see formula (4) for the minimum detectable step in velocity.

$$\Delta v = \frac{c}{2 \cdot f_c \cdot PRI \cdot N_{\text{chirps}}}, \quad (4)$$

where Δv is the resolution in velocity, f_c is the carrier frequency, PRI is the Pulse Repetition Interval and N_{chirps} is the number of pulses in one coherent interval. PRI is 25.3 ms and N_{chirps} is 64. The velocity resolution equals to 0.381 m/s with the maximum ambiguous velocity v_{\max} defined by (5).

$$v_{\max} = \frac{N_{\text{chirps}}}{2} \cdot \Delta v \quad (5)$$

The maximum ambiguous velocity is 12.19 m/s (44 km/h), which fulfilled the time criterion of an alert. If speed of the target is greater than 50 km/h the prototype may provide inaccurate information about Doppler velocity of the detection. The ambiguity of velocity issue can be solved by Chinese Remainder Theorem [6].

Range-Doppler spectrum (2D FFT) is widely used as an estimator of the detection distance and velocity. 2D FFT provides the processing gain (PG) (6), which increase Signal to Noise Ratio (SNR).

$$PG = 10 \log_{10}(M \cdot N) + SNR_{w_d} + SNR_{w_v}, \quad (6)$$

where M , N ($M = 64$, $N = 256$) are number of samples in range and velocity dimensions in 2D FFT. SNR losses are due to windowing function. Losses are given by (7, 8), where is w_d as distance (rows) and w_v as velocity (columns). [9] The proposed design uses Hamming window in the purpose to reduce spectrum side lobes.

$$SNR_{w_d} = \frac{1}{\|w_d\|^2 N} \left| \sum_{k=0}^{N-1} (w_d)_k \right|^2 \quad (7)$$

$$SNR_{w_v} = \frac{1}{\|w_v\|^2 M} \left| \sum_{k=0}^{M-1} (w_v)_k \right|^2 \quad (8)$$

The peaks in the Range-Doppler spectrum represent targets themselves or the noise. That needs to be clarified. Constant False Alarm Rate is the adaptive threshold which decides if it is present target or just is only noise. The performance of a Cell Averaging Constant False-Alarm Rate (CA-CFAR) detector degrades rapidly in non-ideal conditions caused by multiple targets and non-uniform clutter.

The ordered-statistic CFAR (OS-CFAR) is an alternative to the CA-CFAR. OS-CFAR provides small loss in detection performance relative to the CA-CFAR in ideal conditions for much less performance degradation in non-ideal conditions. Formula is given for the probability of detection of OS-CFAR when there are multiple Swerling I targets with nonuniform Raleigh clutter in the CFAR window [6], [7].

As the reflective surface of the car is expected value 10 dBsm. The reliability of the system could be defined by Receiver Operation Curve (ROC) but in this case, it is defined like a combination of probability of detection which is

defined as 0.8 or higher and probability of false alarm as 10^{-4} or less. The maximum allowable delay from received radio frequency signal (RF) to the warning shall not exceed 200 ms to provide the alert in time.

III. SIMULATION

Simulation needs to be done before the experiment begins. Assuming a total of K reflecting objects, the received signal has the form (9) [7], [8].

$$s_2(t) = \sum_{k=0}^{K-1} a_k s_1(t - \tau_k) \exp(j2\pi f_{D,k} t) \exp(j\phi_k) + n(t), \quad (9)$$

where $s_2(t)$ is the received signal a delayed replica of transmitted signal $s_1(t)$ by time shift τ_k of k -th target, a_k is an amplitude of k -th target derived from distance, output power and Radar Cross Section of the target, $f_{D,k}$ is a Doppler frequency and ϕ_k is a phase of k -th target. The model is corrupted by noise $n(t)$, which is assumed additive white and Gaussian with zero mean value. Let suppose 4 different targets (at distances: 20, 30, 40 and 50 m and velocities -2, 12, 5, 10 m/s), one represents incoming and three of them outgoing targets. The signal in time domain of these received signals (targets) in one chirp is shown on Fig. 4. Received signal is weighted by Hamming window in both directions. Radar Cross Section (RCS) of the targets is set to 10 dBsm which is close to RCS of a real car.

The artificial data are like data from ADC. These data should be close to the final platform as much as possible. The sampling frequency is the same as it is in the proposed HW solution [10].

The frequency domain of one chirp is shown on Fig. 5 where peaks represent the positions of the targets above the noise floor.

IV. REAL MEASUREMENT

The prototype of radar system is built on Altera kit with Cyclone V System On Chip (SoC) form Terasic [11], and data convert card (from the same company) with two ADCs and two DACs (Digital-Analog Converter). SoC in this context refers to interconnection FPGA (Field Programmable Gate Array) and ARM (Acorn RISC Machine) processor in one integrated circuit (IC). The mezzanine card with AD-DA converters is interconnected with radar sensor K-LC1a from RFbeam Microwave GmbH. The radar works at 24.125 GHz with bandwidth 180 MHz. Horizontal antenna pattern has 80° and vertical beam is 34° wide [13].

The block diagram of designed system is shown on Fig. 6. DAC is used as a generator of the saw tooth waveform for FMCW signal. Low-noise amplifier (LNA) gains the signal from radar sensor which has just been mixed to intermediate frequency (IF) into a suitable level for the whole dynamics of ADC input. Passive low-pass filter (LPF) is tuned at cut off frequency to suppress undesired frequencies. The main part of the signal processing is based on firmware build into the FPGA. The Bluetooth Module is connected via USB interface.

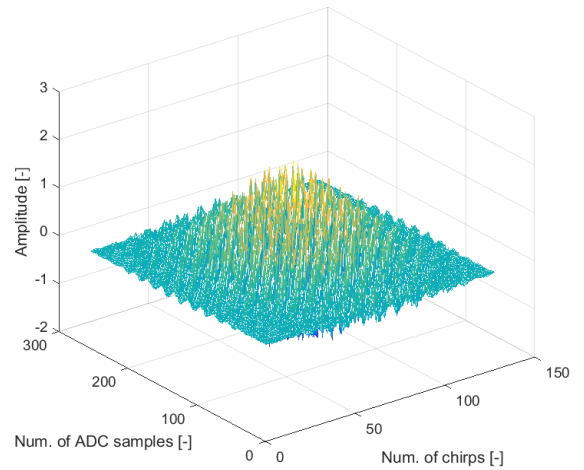

Fig. 4. Targets in the time domain.

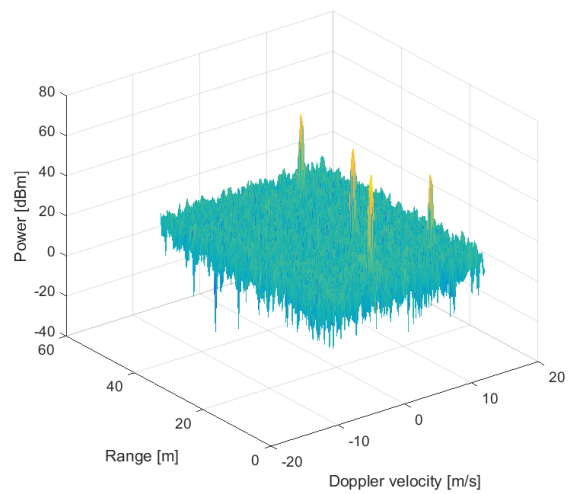

Fig. 5. Targets in the frequency domain.

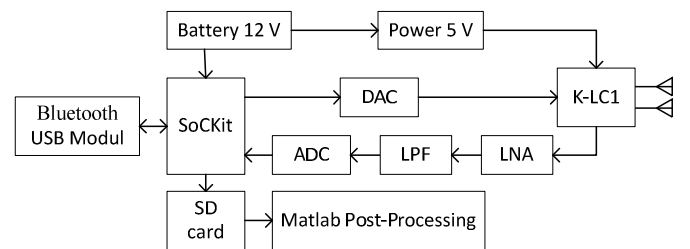

Fig. 6. The design workflow of prototype.

The system is powered by a battery (12 V). The received data (14-bit data length in a matrix size $N \times M$) are stored to a SD Card and data can be used in MATLAB Post-Processing. Fig. 7 and Fig. 8 show the test bed of the HW installed on the bicycle. The radar is located above the rear wheel of the bicycle (Fig. 7). Rest of the HW (the SoCKit, the AD-DA mezzanine card, the battery and the analog front-end) is in the basket (Fig. 8). The radar sensor is interconnected with the conversion card via SMA cables.

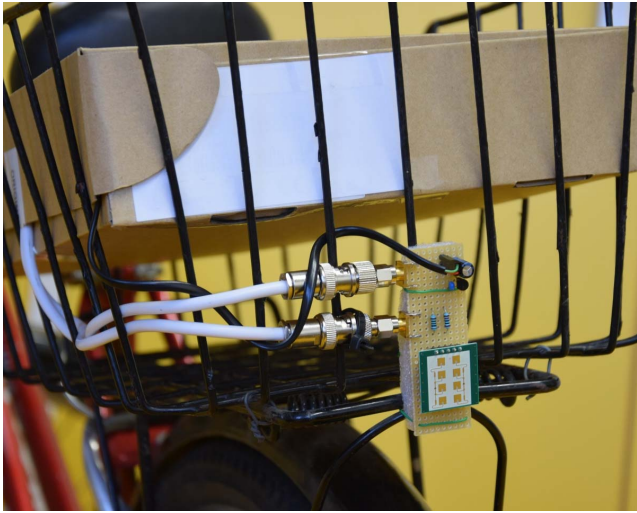

Fig. 7. Installation of the measurement setup - radar sensor on bicycle.

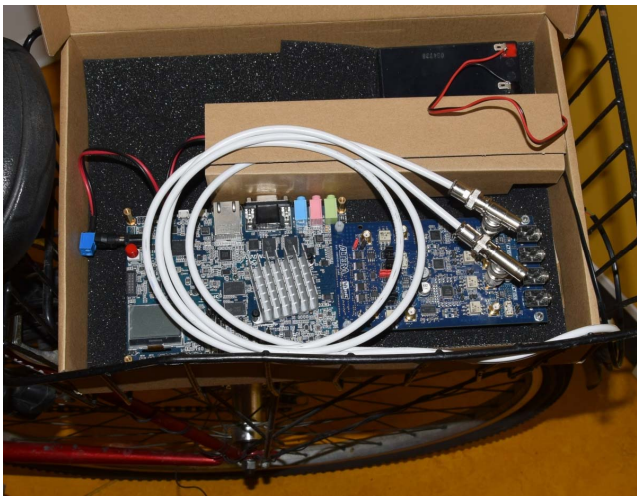

Fig. 8. Installation of the measurement setup - the SoCKit with the AD-DA mezzanine card and the battery.

Prototype testing was performed in the university courtyard. Two situations were tested. The first one: bicycle was static, and the vehicle was approaching to the bicycle, and vice-versa. On Fig. 9 is shown the photo on the courtyard from perspective of the bicycle (radar sensor). The obtained results based on measured data from the first situation are presented on Fig. 10. The peaks in Range-Doppler spectrum on Fig. 9 show more objects with zero velocity than only the vehicle, these are surrounding obstacles (flower pots, lighting column and penthouse). The detected objects are highlighted with the relevant colors in the figures (Fig. 9 until Fig. 11).

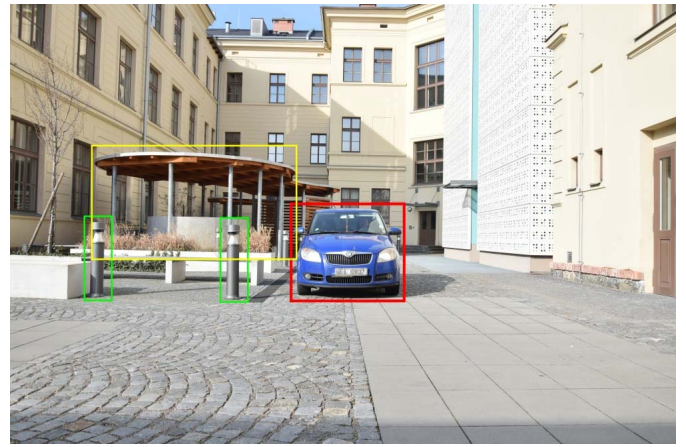

Fig. 9. Photo from the testing - view from the radar sensor.

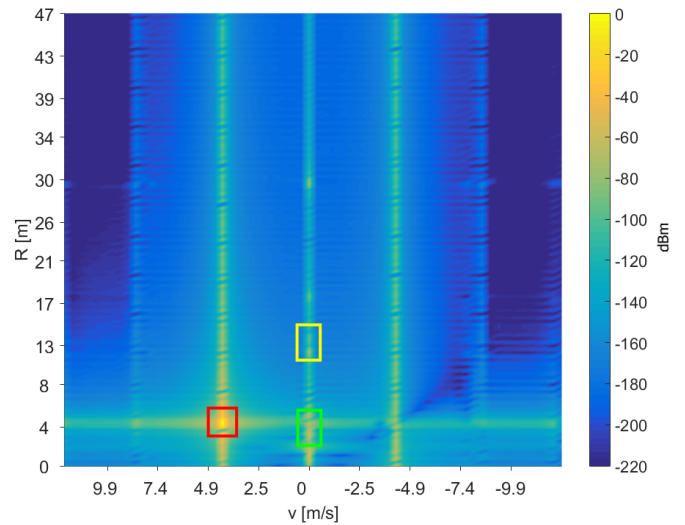

Fig. 10. Results in the form of Range Doppler map - vehicle at a distance 4.5 m.

Three peaks were detected using adaptive threshold and these peaks relate to the targets in the scene. The vehicle velocity was 15 km/h (4.16 m/s) and the distance of the vehicle was 4.5 m (red bordered object). The static objects around the vehicle were detected, and these are marked in the green box. Faintly detectable object (penthouse) is marked as yellow.

The same situation is shown on Fig. 11 but the vehicle is at the distance 11.6 m and it has the velocity 8 km/h (2.2 m/s). The target (penthouse) is at the similar distance as vehicle. The penthouse was not detected due to side lobes of the car.

ACKNOWLEDGMENT

The described research was supported by the Internal Grant Agency of University of Pardubice, the project No. SGSFEI_2017_026.

REFERENCES

- [1] Varia™ Rearview Radar | Garmin, 2017 [online]. Available: <https://buy.garmin.com/en-US/US/p/518151>. [Accessed: 2017-02-03]
- [2] L. Rejfeek, P. Bezousek, O. Fiser, V. Brazda, "FMICW radar simulator at the frequency 35.4 GHz," Radioelektronika (RADIOELEKTRONIKA), 2014 24th International Conference, vol., no., pp.1,4, 15-16 April 2014
- [3] A. Johnson, C. Rupp, B. Wolf, L. Hong and A. Mitra, "Collision-avoidance radar for bicyclist and runners," Proceedings of the IEEE 2010 National Aerospace & Electronics Conference, Fairborn, OH, 2010, pp. 84-91.
- [4] I.V. Komarov and S.M. Molskiy, "Fundamentals of short-range FM radar," Boston: Artech House, c2003, xx, 289 p. ISBN 1580531105.
- [5] J. Pidanic, T. Shejbal, Z. Nemecek, H. Suhartanto, "Advanced targets association based on GPU computation of PHD function," 2015 International Conference on Advanced Computer Science and Information Systems (ICACSIS), Depok, 2015, pp. 13-22.
- [6] M.I. Skolnik, "Radar handbook," 3rd ed., New York: McGraw-Hill Professional, 2008. ISBN 978-0071485470.
- [7] S. Blake, "OS-CFAR theory for multiple targets and nonuniform clutter," in IEEE Transactions on Aerospace and Electronic Systems, vol. 24, no. 6, pp. 785-790, Nov 1988.
- [8] E.W. Kang, "Radar system analysis, design, and simulation". London: Artech House, 2008. ISBN 159693347X.
- [9] M. Braun, "OFDM Radar Algorithms in Mobile Communication Networks," 2014 [online]. Available from: <https://publikationen.bibliothek.kit.edu/1000038892>. [Accessed: 2017-01-25]
- [10] T. Schipper, J. Fortuny-Guasch, D. Tarchi, L. Reichardt and T. Zwick, "RCS measurement results for automotive related objects at 23-27 GHz," Proceedings of the 5th European Conference on Antennas and Propagation (EUCAP), Rome, 2011, pp. 683-686.
- [11] SoCKit - the Development Kit for New SoC Device, 2016 [online]. Available: <https://www.terasic.com.tw/cgi-bin/page/archive.pl?CategoryNo=167&No=816>. [Accessed: 2016-11-12]
- [12] MathWorks, MATLAB and Simulink for technical computing, 2014 [online]. Available: www.mathworks.com. [Accessed: 2014-06-28]
- [13] K-LC1a Radar Transceiver, 2017 [online]. Available: <https://www.rfbeam.ch/product?id=1>. [Accessed: 2017-01-04]

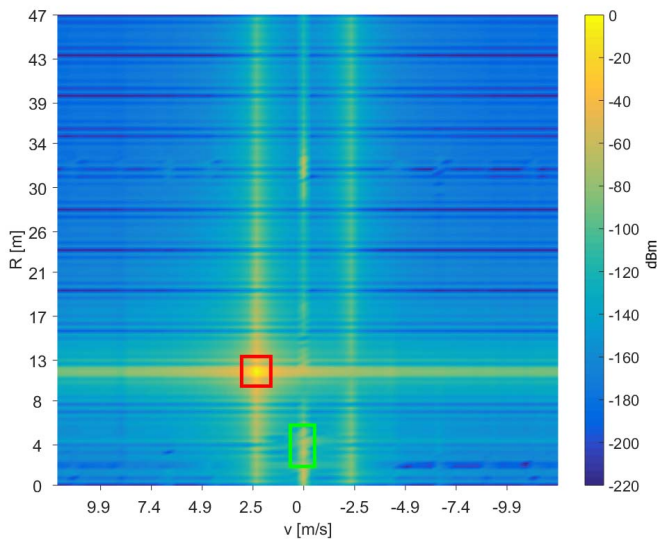

Fig. 11. Results in the form of Range Doppler map - vehicle at a distance 11.6 m.

V. CONCLUSION

The prototype of the close vehicle warning system for bicyclists was introduced. The main parameters were designed and simulated in the MATLAB environment [12]. The real hardware was designed using Altera Cyclone V SoCKit and the low-cost FMCW radar. A cell phone was chosen as a Human User Interface (HUI) to make the device cheaper and widely available. Communication between radar system and a mobile phone is via Bluetooth interface. The measurement provided the promising results. The target was identified as well as other significant subject on the country yard. We are currently working on the tracking algorithm of detections to which is built in ARM processor to provide the information to a user. At the same time work around extension of maximum ambiguous in velocity is in the process. Future work will be focused on the human interface device.