

## POSITION AND VELOCITY MEASUREMENT ACCURACY ANALYSIS OF THE FMCW MULTILATERATION SENSOR

Pavel BEZOUŠEK

Katedra elektrotechniky elektroniky a zabezpečovací techniky

### 1. Introduction

One of the challenging problems in the effort to reach safety transport on roads and railways is an automatic anticollision system providing full automatic cruise control (ACC) of the vehicle, entering into the vehicle driving to solve a crash situation or at least to serve as a driver assistance at critical situations. Such a system should exploit number of various sensors to realize this task. One of the most powerful one is a video camera based system. It has a very good resolution in the transverse coordinates and using modern data processing methods it has also a good chance for a proper recognition of individual obstacles and of their potential threat to the vehicle motion. Unfortunately it has very poor range and velocity resolution, the parameters very important for all systems automatically controlling vehicle drive. On the other hand radar exhibits very good range and radial velocity resolution, having at the same time poor resolution in the transversal coordinates. Naturally these two systems are complementary devices for the obstacle detection and analysis in the vehicle vicinity. A great problem arises in the moment we need to associate the complementary information of the two sensors and to assign them to one object. Then some range and velocity measurement ability of the video camera system and at the same time some angle resolution of the radar are needed to perform reliably this task. There exist some tools to reach those requirements with the camera

system (in a stereoscope or even in a monocular design). However in this article we will deal with the radar sensor system only.

The transversal resolution in radar is usually obtained using directional antennas. To scan the whole inspected angle (about  $90^\circ$ ) a moving beam or a multibeam antenna is needed. To achieve a transversal resolution of 1 m at the range of 30 m it is necessary to have antenna with a 3 dB beamwidth about  $2^\circ$  and with a dimension  $w = 35\lambda$  (i.e.  $w = 3$  m at  $f = 3$  GHz). As much as 45 such beams are then needed to scan full  $90^\circ$  view angle. Such requirements is hard to achieve in practice. Our new proposed system is based on multilateration techniques ([1]), e.g. on multiposition active FMCW radar, consisting of one transmitter and four receivers, localized along the vehicle front line. The objects are detected by this system, their horizontal positions and radial velocities are computed in real time and the selected objects are recognized and tracked. Reports on real detected objects are then passed to the vehicle computer.

In the next Section the system of the radar sensor and the main processing blocs are described. In the Section 3 the mathematical procedures of position and velocity calculation used in the sensor are explained. The Section 4 is devoted to a measurement accuracy evaluation for the procedure of position and velocity calculation used. In the Section 5 the computer model of the sensor in MATLAB is introduced and results of measurement accuracy calculations are shown. The feasibility of the system and its ability to help the anticollision system in the near range is thus demonstrated.

## 2. System description

The sensor consists of one FMCW transmitter, situated typically at the center of the vehicle front and of four identical receivers, symmetrically displaced on both sides of the transmitter in the same line. The situation is shown in the **Fig. 1**. The transmitter generates frequency modulated continuous wave (FMCW) and using simple patch antenna with beamwidth of about  $90^\circ$  in the horizontal and  $30^\circ$  in the vertical planes illuminates the objects in the vehicle vicinity. At the same time, the transmitter delivers a part of its signal to each receiver using coaxial lines of the known lengths. The same antennas are used in receivers. In the transmitter signal modulation, basically a linear frequency modulation with alternating frequency sweep is used.

In the receivers the received signal, scattered by the objects in the vehicle vicinity is mixed with a transmitter signal coming directly from transmitter through the coaxial lines. In the case of existence of only one object in the respective area, signal of intermediate frequency  $f_{if}$  is obtained after a low pass filtering. The block diagram of one of the receivers is shown in the **Fig. 2**. Each transmitter - receiver couple works similarly to the well known concept of FMCW radar for moving targets, described many times elsewhere ([2], [3]). In short: the frequency  $f_{if}$  of the mixed signal depends on the time delay between the received signal, scattered by the object and the transmitted signal and on the relative velocity of the object (Doppler effect). The time delay is due to propagation

of the signal on the total path (elliptical range)  $R_i$  consisting of a trace from the transmitter to the object  $r_0$  plus a trace from the object to the receiver  $r_i$ . (see **Fig. 3**). The total velocity (elliptical velocity)  $V_i$  is the sum of radial velocities of the object to the transmitter and receiver ( $v_0$  and  $v_i$  respectively). Minimally two independent measurement with different frequency slopes are needed to determine both quantities e.g.  $R_i$  and  $V_i$ . To resolve more than one object and to suppress false targets generation four and even more modulation responses are used subsequently in practice.

In the result each transmitter - receiver couple determines uniquely the elliptical quantities  $R_i$ ,  $V_i$  for each target. A system computer uses these parameters to evaluate positions of individual targets. In the single target case the procedure is quite straightforward. The position of target is first computed combining measurement results  $R_i$ ,  $R_k$  of minimally two receivers and solving set of nonlinear equations. Then the object velocity is determined. The respective mathematics is described in details in the next section.

However, usually there are many targets ( $N \approx 20$ ) present at the scene simultaneously. Then we get  $N$  couples  $(R_i, V_i)_p$ ,  $p = 1, 2, \dots, N$  from each receiver. It leads to  $N^2$  possible combinations of results of two receivers and  $N^4$  combinations exploiting results of all four receivers. It generates  $N_{FA} = N^4 - N$  false targets (if  $N=20$ ,  $N_{FA} = 159\,980$ ). Minimally half of them have usually unrealistic positions or velocities and so they are automatically discarded. Further targets could be excluded due to inconsistency in their positions, computed from different combinations of receivers. Finally some false targets rest due to a finite resolution of the system. They could be rejected in the tracking phase only. Sufficient suppression of false targets is vital for the sensor success in real situation so very sophisticated algorithms are used in this stage of the data processing. Nevertheless the substance of all the further operations on acquired data is a quick, accurate and robust algorithm for object position and velocity calculation in the one-target case.

### 3. Object position and velocity calculation

As was explained previously one target situation is assumed in this section e.g. the unique measurement results  $R_i$ ,  $V_i$ ,  $i = 1, 2, \dots, 4$  at the four receivers are assigned to one object. The situation will be described according to the **Fig. 1**. Measured quantities  $R_i$ ,  $V_i$  are defined as follows:

$$\begin{aligned}
 R_i &= r_0 + r_i & V_i &= v_0 + v_i & i &= 1, 2, \dots, 4 \\
 r_k &= \sqrt{(x - x_k)^2 + (y - y_k)^2} & & & k &= 0, 1, \dots, 4 \\
 v_k &= v_x \frac{x - x_k}{r_k} + v_y \frac{y - y_k}{r_k} & & & k &= 0, 1, \dots, 4
 \end{aligned} \tag{1}$$

where:

$x, y, v_x, v_y$ ..... are coordinates of the object position and relative velocity components,  
 $x_0, y_0$ ..... are coordinates of the transmitter,  
 $x_i, y_i$ ..... are coordinates of the  $i$ -th receiver.

The quantities  $R_i, V_i$  are results of standard FMCW radar moving objects parameters measurements (see [4] for instance). In our case there are three modulation responses used in the sensor according to the **Fig. 4**. They are linear FM with radio frequency sweep  $\Delta F, -\Delta F$  and 0 at the common time base  $T_1$ . At the  $i$ -th receiver we measure subsequently three intermediate frequencies  $f_{i1}, f_{i2}, f_{i3}$ , respective to the radio frequency sweeps  $\Delta F, -\Delta F$  and 0:

$$\begin{aligned}
 f_{i1} &= R_i \frac{+\Delta F}{cT_1} - V_i \frac{f_0}{c} + \delta f_{i1} & i = 1,2,\dots,4 \\
 f_{i2} &= R_i \frac{-\Delta F}{cT_1} - V_i \frac{f_0}{c} + \delta f_{i2} & i = 1,2,\dots,4 \\
 f_{i3} &= 0 - V_i \frac{f_0}{c} + \delta f_{i3} & i = 1,2,\dots,4
 \end{aligned} \tag{2}$$

where:

$f_0$ ..... is a minimum RF radar frequency,  
 $c$ ..... is the velocity of light,  
 $\delta f_{ik}$ ..... are frequency measurement errors,  $i = 1,2,\dots,4, k = 1,2,3$ .

This is a set of 12 linear measurement equations for 8 unknown parameters. Combining equations (1) and (2) we get a set of 20 equations for 12 unknown parameters: interesting parameters - object position and velocity  $x, y, v_x, v_y$  and noninteresting ones -  $R_i, V_i$  ( $i = 1,2,3,4$ ). Noninteresting parameters could be excluded analytically (substituting expressions (1) to equations (2)). In our case it would lead to the set of 12 measurement nonlinear equations. In the matrix form we have:

$$\begin{aligned}
 \mathbf{F} &= \mathbf{Q}(\mathbf{P}) + \delta \mathbf{F} \\
 \mathbf{P} &= (x, y, v_x, v_y)^T, \\
 \mathbf{F} &= (f_{11}, f_{12}, f_{13}, \dots, f_{43})^T, \\
 \delta \mathbf{F} &= (\delta f_{11}, \delta f_{12}, \dots, \delta f_{43})^T
 \end{aligned} \tag{3}$$

where:

$\mathbf{Q}(\mathbf{P})$ ..... is a vector function nonlinearly dependent on the state vector  $\mathbf{P}$  uniquely defined by the equations (4)  
 $f_{ik}$  ..... measured intermediate frequencies  
 $\delta f_{ik}$ ..... frequency measurement errors  
 $i = 1,2,3,4$ ..... an order number of the receiver  
 $k = 1,2,3$ ..... an order number of the modulation segment (**Fig. 4**)

Definition of components  $Q_1, \dots, Q_{12}$  of the nonlinear vector function  $\mathbf{Q}(\mathbf{P})$ :  
 for  $i = 1, 2, 3, 4$

$$\begin{aligned}
 Q_{3(i-1)+1} &= R_i \frac{+\Delta F}{cT_1} - V_i \frac{f_0}{c} \\
 Q_{3(i-1)+2} &= R_i \frac{-\Delta F}{cT_1} - V_i \frac{f_0}{c} \\
 Q_{3(i-1)+3} &= -V_i \frac{f_0}{c}
 \end{aligned} \tag{4}$$

$$\begin{aligned}
 R_i &= \sqrt{(x-x_0)^2 + (y-y_0)^2} + \sqrt{(x-x_i)^2 + (y-y_i)^2} \\
 V_i &= \frac{v_x(x-x_0) + v_y(y-y_0)}{\sqrt{(x-x_0)^2 + (y-y_0)^2}} + \frac{v_x(x-x_i) + v_y(y-y_i)}{\sqrt{(x-x_i)^2 + (y-y_i)^2}}
 \end{aligned}$$

Now we have 12 measurement equations for 4 interesting parameters, mentioned above. In the case, the measurement errors are zero mean normally distributed, least square (LS) method is usually applied to find the estimation. The aim is to search for parameters estimation  $\mathbf{P}$ , minimizing the sum of squared measurement errors:

$$\sum_k (\delta f_{ik})^2 .$$

In such a situation the found estimation fulfills the maximum likelihood (ML) criterion. In our case the measurement errors  $\delta f_{ik}$  are not normally distributed. We may also apply the LS method to find an estimation of the object position and its velocity but the found estimation will not satisfy the ML criterion. Due to the nonlinearity of the equations a direct expression for the estimation is not known. Instead we use a method of step-by-step approximations. In the first step we start with an initial approximation of the object position and velocity (for inst.  $\mathbf{P}_0 = 0$ , e.g.:  $x = y = 0$ ,  $v_x = v_y = 0$ ). Then the equation (3) is linearized in respect to  $\mathbf{P}$ :

$$\begin{aligned}
 F &= \mathbf{Q}(\mathbf{P}_0) + d\mathbf{Q}(\mathbf{P}_0) \cdot \Delta\mathbf{P}_1 + \delta F \\
 d\mathbf{Q} &= \left\| dQ_{pr} \right\|_p, \quad dQ_{pr} = \frac{\partial Q_p}{\partial P_k}
 \end{aligned} \tag{5}$$

where:

$d\mathbf{Q}(\mathbf{P}_0)$  .....is a matrix of derivatives  $\mathbf{Q}(\mathbf{P})$  in respect to  $\mathbf{P}$  at the point  $\mathbf{P}_0$

$\Delta\mathbf{P}_1$ .....is the first correction of the object parameters.

The set (5) is a set of 12 linear measurement equations for 4 unknown parameters, represented by components of the vector  $\Delta\mathbf{P}_1$ . Here we may apply the LS method to find estimation of  $\Delta\mathbf{P}_1$ . As was stated above, the measurement errors are not normally distributed but it could be shown they have zero mean and they are not mutually correlated neither between individual receivers nor between the individual modulation segments at the same receiver. They have also the same variance  $\sigma_f^2$ . Then we may

represent the variance matrix of  $\delta\mathbf{F}$  as a product of a constant and an identity matrix and for the first correction  $\Delta\mathbf{P}_1$  we will get (after [5]) the following expression:

$$\Delta P_1 = (dQ^T \cdot dQ)^{-1} \cdot dQ^T \cdot [F - Q(P_0)] \quad (6)$$

provided:

$$\text{var}(\delta\mathbf{F}) = \sigma_f^2 \cdot \mathbf{I}$$

where:

$\text{var}(\delta\mathbf{F})$  ..... is a variance matrix of the vector  $\delta\mathbf{F}$ ,

$\mathbf{I}$  ..... is an identity matrix.

Then a new approximation is computed as:

$$P_1 = P_0 + \Delta P_1 \quad (7)$$

The steps are then repeated as described above. Number of approximation steps needed to reach a good accuracy depends mainly on a quality of the first approximation. If the object is tracked by the sensor then only one step is usually sufficient. But for a new target or at a rapid change of situation as much as 8 steps are frequently needed.

#### 4. Accuracy of target parameters analysis

Also in this section we will keep an assumption of the one target situation as it was explained above. The process of the object parameters (horizontal position and velocity) determination has been described in the previous section. It is a procedure of solution of the equations (3) using the expressions (4), which result in a set of 12 nonlinear measurement equations for four object state parameters  $x$ ,  $y$ ,  $v_x$ ,  $v_y$ . One part of this procedure is a solution of a linearized set of equations for parameters corrections. In this section we will deal only with this linearized system. Our analysis will start at the final approximation step - the solution of the linearized equation (5) using expression (6). In this section we would like to find how far would be the found estimation from the true object parameters due to measurement errors. These errors are random variables so the estimated parameters should be also random variables. Moreover because the measurement errors have zero mean the LS method leads to an unbiased estimation. Then the needed information on accuracy of the parameters evaluation using the described computation method could be extracted from the variance matrix  $\mathbf{S}$  of the last correction of parameters  $\Delta\mathbf{P}_n$ .

To find the expression for this variance matrix let us imagine the situation, that approximation  $\mathbf{P}_{n-1}$  represents an exact state of the object. Then:

$$F = Q(P_{n-1}) + \delta F \quad (8)$$

And hence the further correction  $\Delta\mathbf{P}_n$  would have been zero. Instead we will find according to the expressions (6) and (8):

$$\Delta P_n = (dQ^T \cdot dQ)^{-1} \cdot dQ^T \cdot [F - Q(P_{n-1})] = (dQ^T \cdot dQ)^{-1} \cdot dQ^T \cdot \delta F \equiv \delta P \neq 0 \quad (9)$$

The equation (9) expresses the deviation  $\delta\mathbf{P}$  of our estimation due to measurement error  $\delta\mathbf{F}$ . For variance matrix of this deviations we get (see [5]):

$$\mathbf{S} \equiv \text{var}(\delta\mathbf{P}) \equiv \text{var}(\mathbf{P}) = [\mathbf{dQ}^T \cdot \text{var}^{-1}(\delta\mathbf{F}) \cdot \mathbf{dQ}]^{-1} \quad (10)$$

In the next section we will demonstrate the sensor accuracy in typical situations on a computer model.

## 5. Modeling the sensor

For better understanding of problems in the sensor design and its function there was created a model of the sensor in MATLAB with parameters, listed in the **Tab. 1**. The geometry of the sensor and object is shown in the **Fig. 5**.

Examples of computed results are demonstrated in the **Fig. 6** through **Fig. 8**. Errors in horizontal position of the object are smaller than 1 m up to the maximum range of 30 m. In the nearby area these errors fall down to less than 0,2 m, what is quite suitable for the intended application.

**Tab. 1** Parameters of the sensor model

Parameter	Symbol	Magnitude	Notes
Transmitter frequency	$f_0$	10 GHz	minimum frequency
Frequency sweep	$\Delta F$	1 GHz	bandwidth = $\langle f_0, f_0 + \Delta F \rangle$
No of transmitters/receivers		1/4	for geometry see <b>Fig. 5</b>
Maximum range	$R_{max}$	31 m	
Covered area	$w \times R$	12 m x 30 m	see <b>Fig. 5</b>
Base	$L$	4 m	maximum distance of receivers
Number of modulation segments		3	$+\Delta F, -\Delta F, 0$ (see <b>Fig. 4</b> )
Time base	$T_1$	5 ms	one modulation segment

The same could be said about the  $v_y$  component of the object relative velocity error which is roughly in the range of 1÷2 m/s. The measurement error of the other horizontal component  $v_x$  is much worth, because the system geometry is in principle insensitive to this component. Fortunately the  $y$ -component of the relative velocity is much more important for anti-crash applications than the other one.

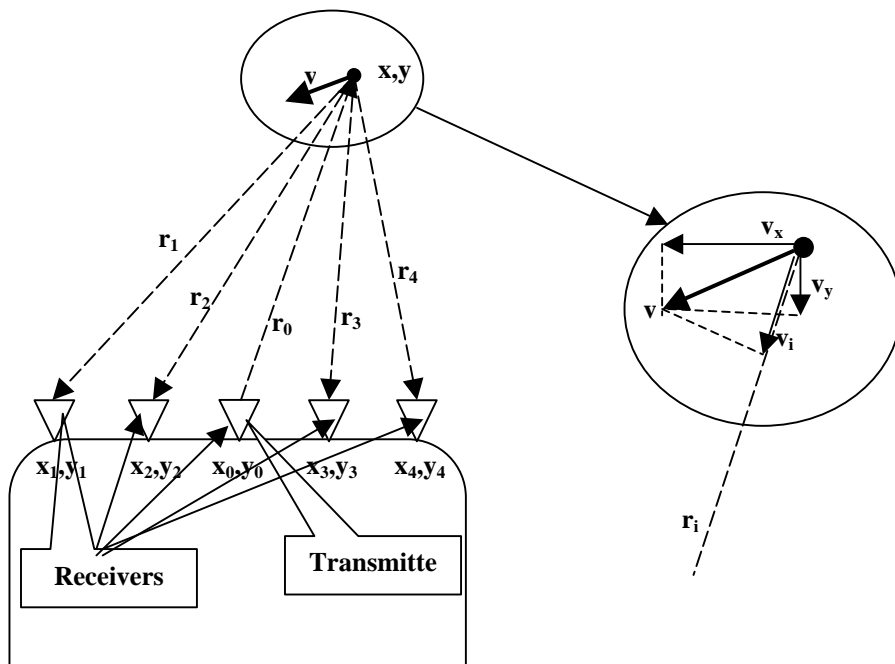
## 6. Conclusion

In the article it was described a multiposition radar FMCW sensor for object detection in the vehicle vicinity. It was demonstrated that such a sensor could reach a suitable accuracy of horizontal position measurement and of measurement of one component of the relative horizontal velocity. The system is sensitive primarily to the

radial velocity due to the exploitation of the Doppler effect. Fortunately this is the most important component of the relative velocity from the point of view of anticollision application. The other components could be estimated from subsequent measurement of the object position during the tracking phase of the data processing. It should be noted, that the accuracy of position measurement shown in the **Fig. 6** could not be reached in practice because we assumed a point object here, what is hardly to imagine in our case when the elliptical range resolution is as good as 30 cm.

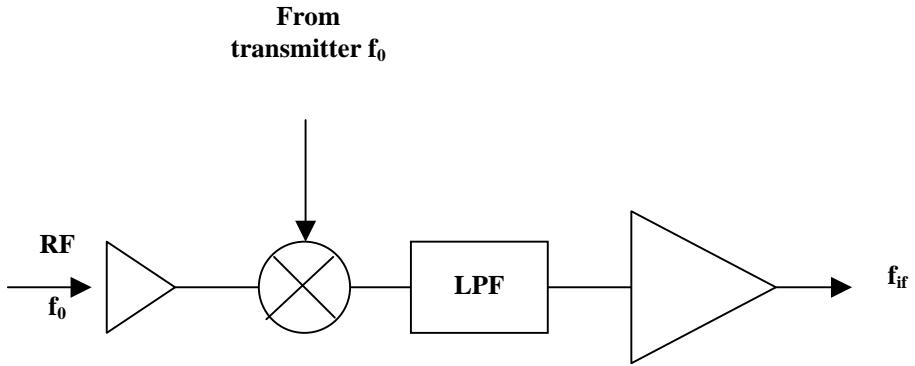
Another problem in the described system is connected to elimination of the false targets. To do this we should compute positions of all targets from all combinations of the data from all receivers and all modulation segments. As was shown above it needs to solve the set of 12 nonlinear equations for each combination. Unfortunately the described procedure converges rapidly only for real targets. That is why more effective though less accurate position computation procedure for a more rapid false targets elimination is now under development.

This work has been supported by the project of Grant Agency of Czech Republic No. 102/03/ 0871 and by the Institutional Research Fund/2004 of theTransport Faculty Jan Perner, University of Pardubice.

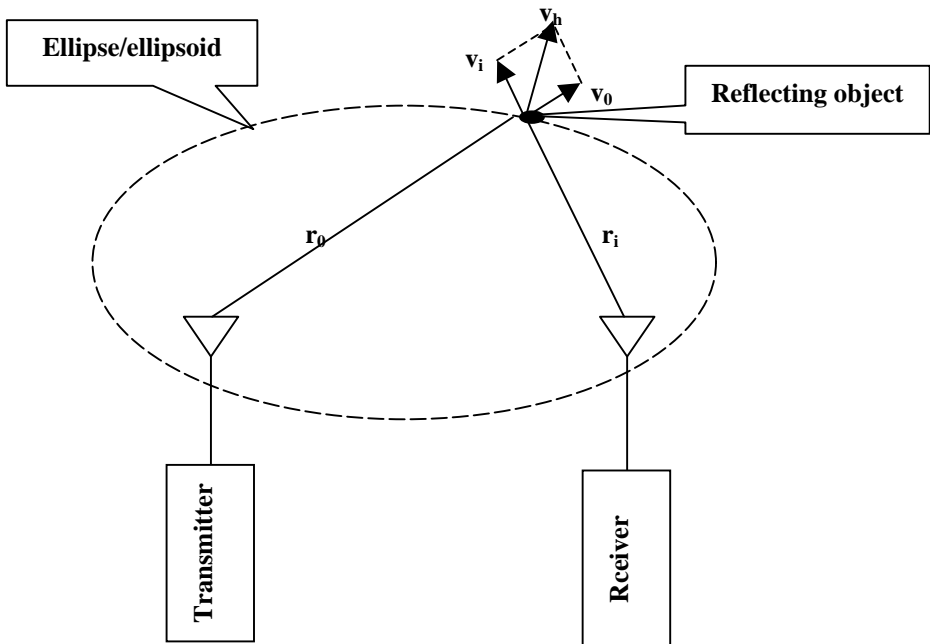


**Fig. 1** Multiposition radar sensor - the situation

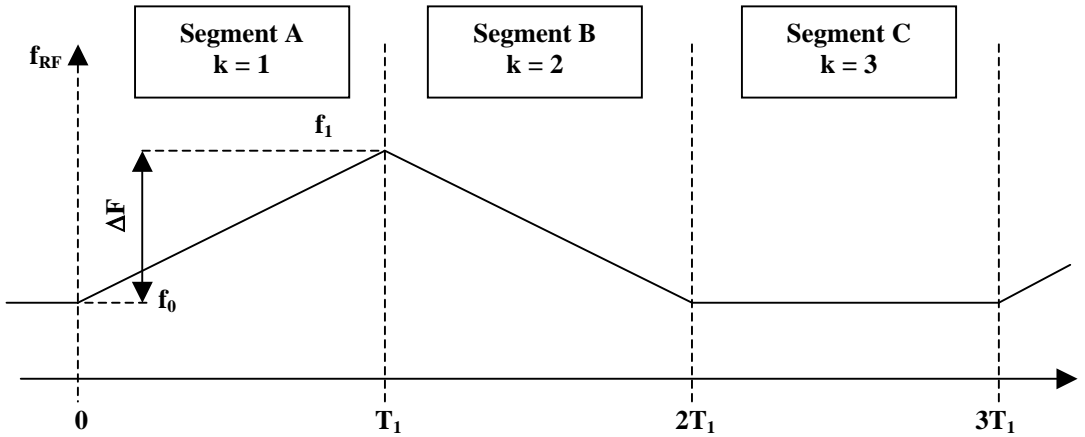




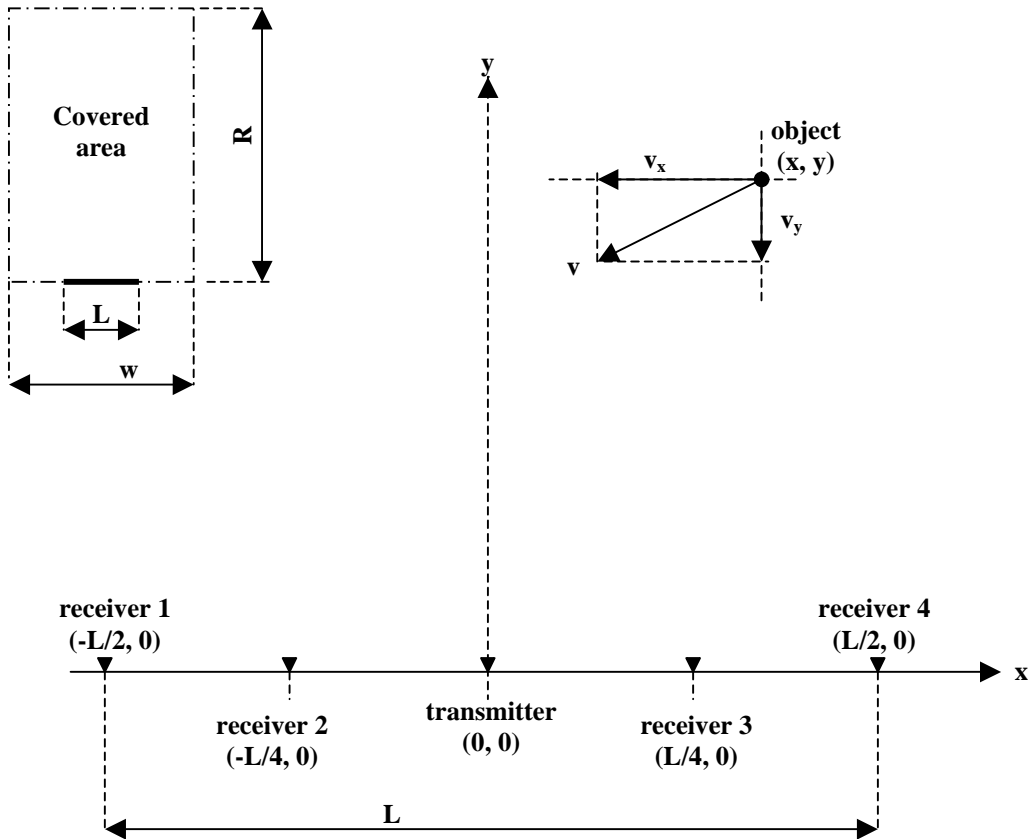
**Fig. 2** The receiver



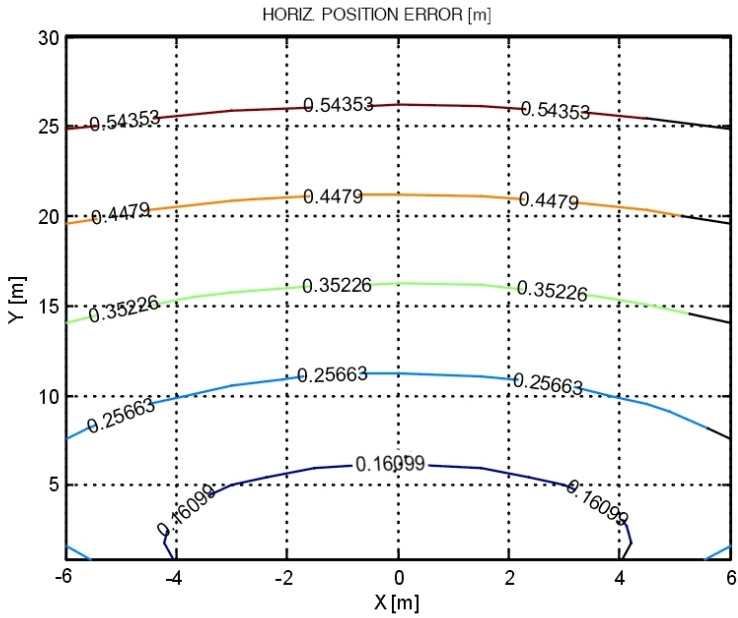
**Fig. 3** Elliptical triangulation



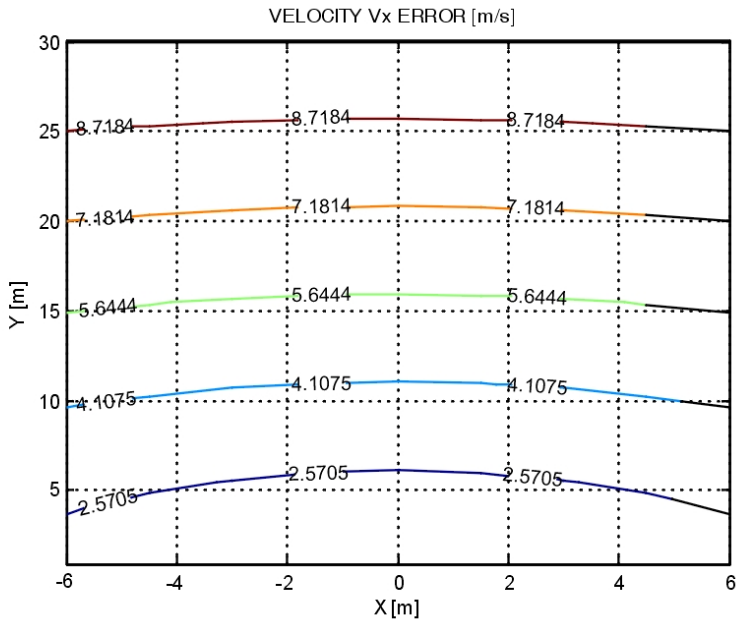
**Fig. 4** Frequency modulation diagram of the FMCW radar



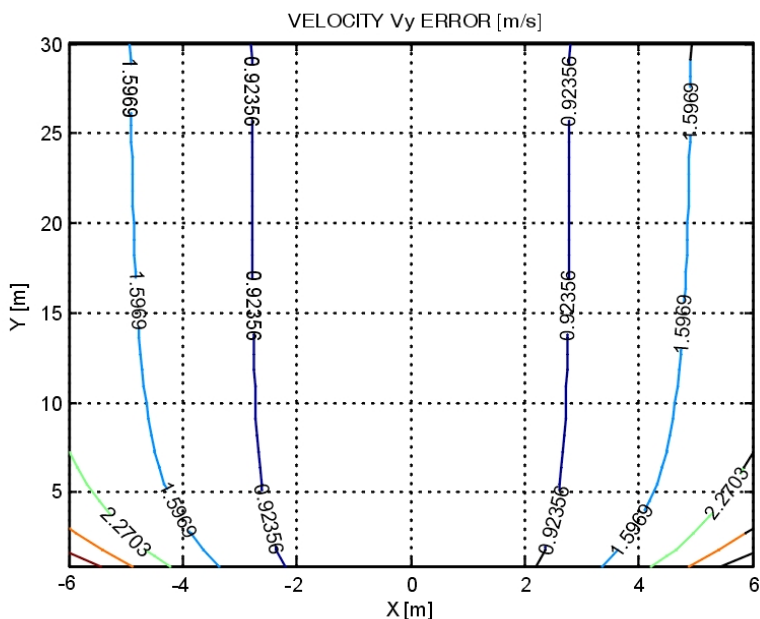
**Fig. 5** Sensor and object geometry for simulation



**Fig. 6** Horizontal position error (standard deviation). For model parameters see **Tab. 1**.



**Fig. 7** Velocity component  $v_x$  error (standard deviation). For model parameters see **Tab. 1**.



**Fig. 8** Velocity component  $v_y$  error (standard deviation). For model parameters see Tab. 1

### References

1. KOENKE E J., GEYER M., LAY R., VILCANS J. *Beacon Multilateration System to Facilitate ADS-B. The 53rd ION Conference Proceedings*, Albuquerque, June 30 - July 2, (1997).
2. KLOTZ M., ROHLING H. *A High Range Resolution Radar System Network for Parking Aid Application. MICON2000*, Wroclaw, May (2000), Proc. pp. 359 - 362
3. MICHAEL B., MENZEL W., GRONAU A. *A Real-Time Close-Range Imaging System with Fixed Antennas. IEEE Transactions on MTT*, Vol. 48, No 12, December 2000, pp. 2736 - 2742
4. BEZOUSEK P. *Anticollision radars in the road transport. Conf. on Microwaves in Transport*, Prague, April 2001, Proc. pp. 11–20 (in Czech)
5. HRDINA Z. *Statistická radiotechnika*. Vyd. ČVUT, (1996), ISBN 80-01-01489-4

Lektoroval: Ing. Miloslav Macho, CSc.

Předloženo: 22. 2. 2005

## **Resumé**

### **ANALÝZA PŘESNOSTI MĚŘENÍ POLOHY A RYCHLOSTI U MULTILATERAČNÍHO FMCW ČIDLA**

Pavel BEZOUŠEK

Článek se zabývá navrhovaným systémem multipozičního radarového čidla, založeného na principu radaru FMCW a určeného ke zjišťování překážek v blízkosti vozidla. Tento radar je součástí komplexnějšího sensorového systému, připravovaného antikolizního systému. Radarový senzor se skládá z jednoho vysílače a ze čtyř identických přijímačů, umístěných na přední části vozidla. Poloha překážky a její rychlost v horizontální rovině se určí eliptickou multilaterační metodou. V článku je podrobněji popsán tento senzor a použitá metoda výpočtu polohy a rychlosti. Dále je zde analyzována přesnost takových měření a na počítačovém modelu je ukázáno, že tento typ senzoru je schopen určovat polohu a relativní rychlost překážek s dostatečnou přesností.

## **Summary**

### **POSITION AND VELOCITY MEASUREMENT ACCURACY ANALYSIS OF THE FMCW MULTILATERATION SENSOR**

Pavel BEZOUŠEK

This article deals with a designed system of a multiposition radar sensor for obstacle detection in the vehicle vicinity, based on FMCW concept. The radar is proposed as a part of a complex sensor system of a prepared vehicle anticollision system. The radar sensor consists of one transmitter and four identical receivers, situated at the vehicle front. The obstacle position in the horizontal plane and its horizontal relative velocity are determined using elliptical multilateration method. In the article the sensor system is described in details and obtainable accuracy of position and velocity measurements are analyzed on a computer model of the sensor.

## **Zusammenfassung**

### **DIE GENAUGIGKEITSANALYSE FÜR POSITIONS- UND GESCHWINDIGKEITSMESSUNG DES FMCW MULTISEITENGEBERS**

Pavel BEZOUŠEK

Der Artikel beschreibt vorgeschlagenes System des Multiposition Radarsgebers, der auf dem FMCW Basis gegründet ist. Dieses Radar ist ein Teil des Komplexgebersystems vorbereitet für Antikollisionssystem. Der Radarsgeber besteht aus einem Sender und aus vier identischen Empfängern, platziert auf dem vorderen Fahrzeugteil. Die Hindernisposition und ihre Geschwindigkeit in horizontal Ebene wird durch elliptische Multiseitenmethode festgestellt. Dieser Geber und die ausgenützte Berechnungsmethode sind in diesem Artikel detailliert beschrieben. Weiter ist die Genauigkeit solcher Messungen analysiert und mit Hilfe des Computermodells es ist gezeigt, dass dieser Gebertyp die Position und relative Hindernisgeschwindigkeit mit ausreichender Genauigkeit feststellen kann.