

## COMPARISON OF PULSE MODE ND:YAG LASER ASSISTED METAL PLASTIC JOINING WITH COMPETITIVE TECHNOLOGIES

Andor BAUERNHUBER, Tamás MARKOVITS

Department of Automobiles and Vehicle Manufacturing, Budapest University of Technology and Economics

### 1. Introduction

Nowadays, different materials are often simultaneously used and built together in our devices in order to create high strength but low weight hybrid parts. The most characteristic hybrid parts are consisting metals and plastic to ensure the required properties. Therefore metals and plastics have to be joined together [1, 2]. The introduced trend is typical for vehicle industry, where the application of hybrid parts allows to fulfil reduction of CO<sub>2</sub> emission, meeting environmental protection demands [3, 4].

Generally, metal-plastic hybrid joints can be produced with and without heat input. Recently applied industrial technologies work mostly without heat input. Such techniques are for example screwing, riveting and the most commonly used gluing. However, each of the listed method has significant drawbacks. The disadvantage of mechanical fasteners is the mechanical stress peak formed in the base material and the difficult automation [5, 6]. Adhesives provide a solution for this problem but they have their own disadvantages: the complicated sample preparation, the need for additional material and also for material handling. Furthermore adhesive curing times are long and the additional materials contain harmful compounds [7].

Laser joining can provide a solution for above introduced concerns due to benefits of laser technologies. Laser beam is able to join metals and plastics very fast, accurately and directly, without any additive materials [8]. Nevertheless there is a difference between the application of continuous mode and pulse mode laser beam. The mentioned difference can cause alteration in the quality of laser joining as well.

The authors have been researching laser assisted joining of plastic and metal materials for years [9, 10]. To choose the proper joining technology, the differences, the advantages and disadvantages have to be known. To be able to position the laser

assisted metal plastic (LAMP) joining well among the other processes, the received results of thermal process have to be compared.

In the present research, steel pins and PMMA plastic plates were bonded by pulse mode and continuous mode Nd:YAG laser source as well as adhesive materials. Our aim was to create pin-to-plate hybrid joints in order to determine the joint strength resulting from different processes, and varying the process parameters (laser heating time, sheet thickness, penetration depth, adhesive material). These differences are discussed.

## 2.Experiments

The material used in the case of joining experiments was 5 mm diameter unalloyed S235 structural steel pin and 2 mm thick, 15 x 15 mm square shaped poly(methyl metacrylate) plastic sheet (Acriplex - PMMA XT – A-Plast company). The geometry of the applied materials are shown in figure 1.

To investigate the bonding force, the joined workpieces were torn, the force was measured with a force tester PCE FG 500. The tester records the force values as a function of time. The tearing speed was 75 mm/min. In the results the force values are indicated because the bonding area could not be obviously determined. Therefore the maximum tearing force was used to characterize the strength of the joint.

### 2.1 Laser joining experiments

In the basic case joining was created by a LASAG SLS 200 type, pulse mode Nd:YAG laser with a maximum average power of  $P_a = 200$  W. The continuous mode laser used for comparing experiments was a Rofin DY 027 type Nd:YAG laser with a maximum power of 2.7 kW. The power distribution of the laser beam was Gaussian ( $TEM_{0,0}$ ) in both cases. The diameter of the laser spot on the surface of the steel pin was 5 mm. The spot was coincident with the face surface of the pin, there was no movement during the process. Argon shielding gas was used and its amount was 4.75 l/min. The experimental setup can be seen in figure 1.

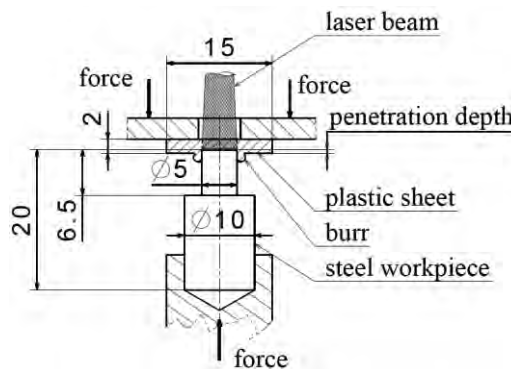

**Fig. 1** Experimental setup of laser joining

During joining the sample was irradiated from the plastic side. The plastic is highly transparent (93 %) to the laser beam [11], so the beam transmits through the plastic and is mainly absorbed by the steel surface. Therefore the steel pin is heated directly which transfers the heat back to the plastic. The plastic becomes softer and finally melts due to

the heat input. The softened material flows back along the lateral surface of the pin and forms a burr ring at the entrance hole. At the end of the process, the steel pin is penetrated into the sheet and is surrounded by a burr ring. After some seconds of cooling, the joint is created.

The applied laser settings in the case of pulse mode laser beam were the following:  $f_p = 100$  Hz,  $t_p = 0.5$  ms,  $E_p = 2$  J, where  $f_p$  is the pulse frequency,  $t_p$  is the pulse duration time and  $E_p$  is the pulse energy. The average laser power was 200 W by applying pulse mode and continuous mode laser beam as well. The applied settings can be seen in table 1.

**Table 1** Laser setting parameters.

Setting	Laser mode	Interaction time (s)	Clamping force (N)	Penetration depth (mm)	Sheet thickness (mm)
1	pulse mode	3 – 7	3,2	0,1 – 1,8	2
2	pulse mode	3	6	0,4	5
3	pulse mode	9	6	3	5
4	continuous mode	2 - 5	3,2	0,25 – 1,9	2

To investigate the internal stress state of the plastic material a self-made polariscope was used, which is able to visualize the stress and strain state of the material surface: the sample was putted between two parallel linear polarizer where the polarizer planes were perpendicular to each other. White light was used to illuminate the sample, and an edge test was used to identify the sign of the stress.

## 2.2 Adhesive bonding experiments

In case of the gluing experiments the base materials were the same. In some cases the plastic sheets were manufactured by milling technology to create a blind hole into the material similar to the holes which were created by the hot pin during the thermal process. The bottom of the milled hole was flat and perpendicular to the middle axes of the hole for adjusting to the geometry of the pin. In other cases the head surface of the pin was glued directly to the surface of the plastic sheet without preparing a hole in the sheet.

The gluing materials were Loctite 454 and Loctite 496 cyanoacrylates. LOCTITE® 454™ is recommended for the assembly of difficult to bond materials which require uniform stress distribution and strong tension and/or shear strength. The product provides rapid bonding of a wide range of materials, including metals, plastics and elastomers. The gel consistency prevents adhesive flow even on vertical surfaces. LOCTITE® 496™ is a general purpose adhesive and is particularly suited to bonding of metal substrates. Loctite 496 has a liquid phase consistency.

Just before the gluing process the samples were cleaned from any contaminations with wound petroleum. The adhesive was placed on the top surface of the pin and the two samples were pressed together with the same equipment that was used in the laser process with the force of 2,5 N for 3 minutes. After clamping, the samples were stored under ambient conditions for 24 hours.

### 3.Results

#### Comparison of different laser joining methods

In figure 2. the penetration and the tearing force of the laser joined samples can be seen as a function of heating time. As mentioned before, the average laser power is the same in both cases ( $P_a = 200$  W), however in the case of pulse mode laser beam, separate short and high power pulses are applied, while in the case of continuous mode laser beam the output power is continuous, and has the same value during the whole irradiation. If the heating time is longer, the temperature of the pin rises, the viscosity of the plastic decreases and the pin can penetrate deeper into the molten plastic as an effect of the applied clamping force. If the penetration is deeper, the contact surface increases between the joined materials, which results in a stronger adhesion and a higher tearing force value. Therefore in the investigated case tearing force can be increased with increasing the penetration, however penetration is limited by the plastic sheet thickness [10].

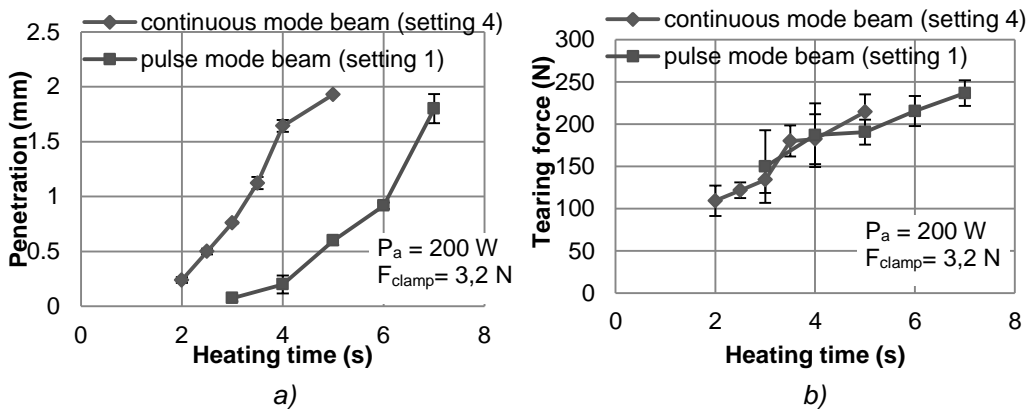

**Fig. 2** Penetration (a) and tearing force (b) of joints as a function of heating time in case of pulse mode and continuous mode laser beam joining

In the case of pulse mode laser beam the joining can be created between the heating times of 3 and 7 seconds: by using a shorter heating time we do not get a joining because the plastic do not melts while by using longer heating time the pin perforates the plastic: the theoretical penetration is larger than sheet thickness. It can be seen, that at the same heating time the penetration of the continuous mode beam made joining is 3,2 to 5,6 times bigger, than those made with the pulse mode laser beam, while the tearing force is nearly the same. It follows that the time range suitable for joining with continuous mode beam is shifted downwards: joining can be created in a heating time range of 2 to 5 seconds. It can be also seen, that at the same penetration the tearing force of the pulse mode beam created joining is higher than those created with continuous mode beam. The difference is caused by the heating process: by applying continuous mode beam the heat input and the surface temperature of the steel pin is higher compared to the application of pulse mode beam. The temperature of the pin is higher than the decomposition temperature of the plastic which results in a bubble formation phenomenon. During plastic decomposition bubbles form next to the joining boundary:

the bubbles are composed by the gas phase decomposition products of the plastic. The mentioned bubbles weaken the joint since there are material discontinuities [9]. This phenomenon is characteristic for this joining method because bubbles are created in the whole process window. The higher temperature in the case of continuous mode heating results in higher penetration but in a more intensive bubble formation too. The mentioned bubbles deteriorate the effect of penetration and result in a lower tearing force. By applying pulse mode laser beam the heat input and therefore the pin surface temperature is lower and bubble formation less intensive, which explain the higher tearing force value. The formed bubbles next to the face surface can be seen in figure 3. at the same heating time of 4s.

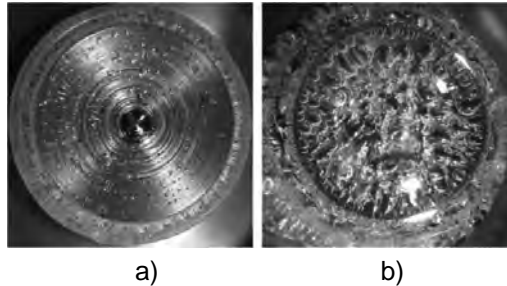

**Fig. 3** Difference between bubble formation next to the face surface of the pin in case of pulse mode (a) and continuous mode (b) laser beam at 200 W average laser power, 4 s heating time and 3,2 N clamping force

### Comparison of adhesive joining and pulse mode laser joining

The laser assisted joining and the adhesive bond can be seen in figure 4. from top and side view. In case of the glued sample, a little amount of adhesive material flowed out from the interface. Based on the curvature of the cured adhesive, a well wetting situation can be seen at the entrance of the bond. This indicates that the cleaning process was appropriate.

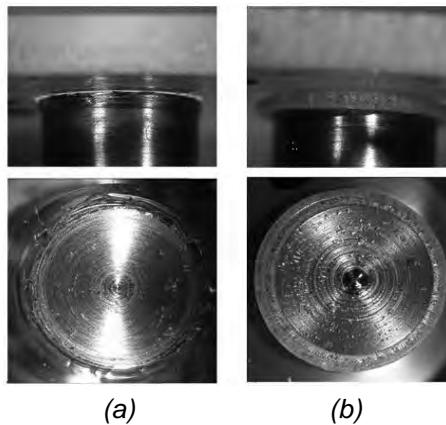

**Fig. 4** View of the different joints (a) adhesive joining, (b) laser joining

To analyze the inner characteristics of the bonded samples, the cross sections of joints are illustrated in figure 5. In case of laser bond, the burr can be seen, which is the material displaced by the pin during joining. The joint was formed at the face and the cylindrical surface too. The glued joint can be seen in figure 5 (a). At each glued sample the gap between the pin and the prepared hole was less than 0,09 mm. The adhesive material filled out the gap and there was not any lack of continuity detected. This leads us to believe that the applied adhesive quantity was adequate.

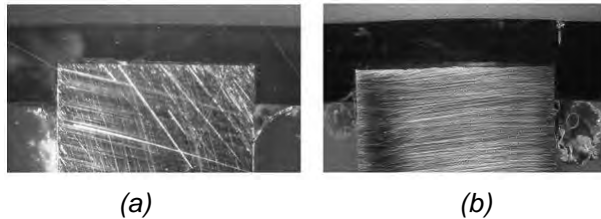

**Fig. 5** Cross sections of the different joints (s) adhesive joining, (b) laser joining

Characteristic tearing diagrams are shown in figure 6., where force values are represented as a function of tearing time. In the introduced cases the penetration depth was 0,9 mm. The diagram shows that the tearing is similar in the course of the uploading until it reaches the maximal force. In case of adhesive joining after reaching the maximum value it drops suddenly near to zero. In case of laser joints, the force drops to a certain value caused by the tearing of pin face surface and then, from this point decreases monotonously and slowly until reaching zero. This phenomenon is caused by the shrinkage force, which was realised between the steel pin and the plastic sheet. There is an eightfold difference between the heat expansion coefficient of steel and plastic which results in a shrink fit between the pin and the sheet after cooling down. The tearing force decreases progressively to zero according to the decreasing friction between lateral pin surface and plastic sheet during tearing. The deeper the penetration depth, the longer the time or elongation length where the value decreases to zero.

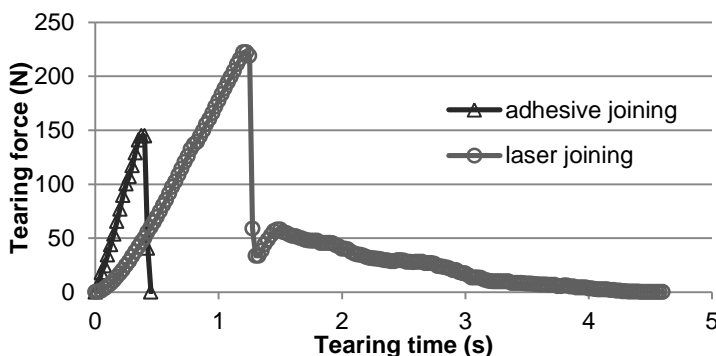

**Fig. 6** Characteristic tearing force curves in case of different joining processes

As a result of the mentioned plastic shrinkage, compressive stress arises in the plastic sheet around the steel pin, as it can be seen in figure 7., where the stress optic photographs of the sample are shown. According to the results it can be stated, that the

shrinkage of the plastic contributes to the formation of joint strength has a positive effect on the value of tearing force.

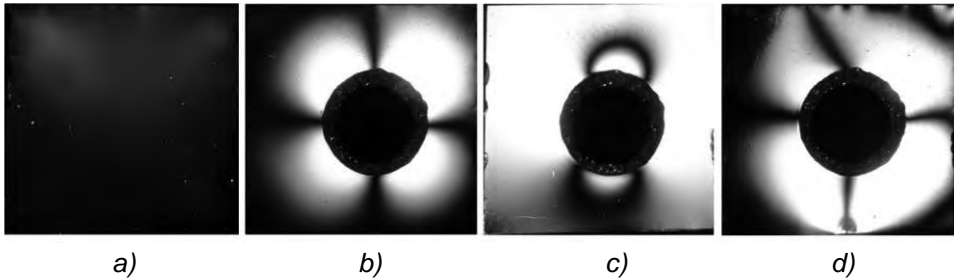
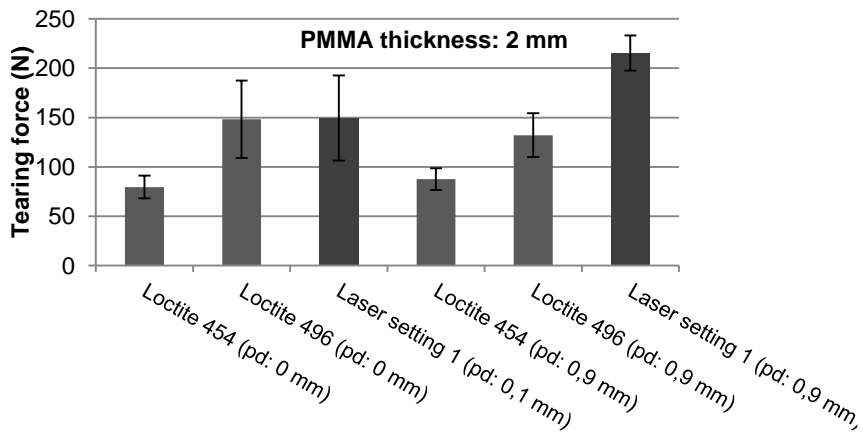

**Fig. 7** Stress and strain state of the plastic sheet before joining (a), and after joining (b, c, d). Compared to picture b) sample is rotated with 45° in picture c), while edge test is applied in figure d)

Analyzing the tearing diagrams, the maximum tearing forces are determined and illustrated in Fig. 8 in case of laser assisted joining and adhesive joining, when the applied sheet thickness was 2 mm. The penetration depths were chosen to be similar or equal in both joining methods. Shortest heating time (3 s) caused a penetration of 0,1 mm. Below this penetration, it was not possible to realise the joint. That is the reason why it was compared with adhesive bonding of zero penetration.

The applied two adhesive materials showed big differences in maximal tearing forces. This value in case of Loctite 496 was two times higher than that of Loctite 454. But, as compared with the values of laser assisted joint, the highest adhesive joint showed almost the same strength in this case.

If the penetration depth was increased to 0,9 mm, tearing force values of glued joints are close to match values at zero penetration depth. In these cases the cylindrical surface of the steel pin took part in the joint as well however the maximum tearing forces did not get enhanced by the deeper penetration. This situation should be better in case of adhesive joining, because shearing plays a role besides the pulling stress which is realised at the face surface. The laser assisted joint shows more than 60 % higher maximum tearing force than the adhesive bonding if the sheet thickness is 2 mm.



**Fig. 8** Maximum tearing forces in case of different joining process (pd: penetration depth)

In case of laser joining of 5 mm thick sheets, the lowest pin penetration was 0,4 mm. Therefore the joining with 0,4 mm penetration was compared to the adhesive joining without prepared hole (zero penetration). The other laser caused penetration depth - used in comparison - was 3 mm. Analysing the results, it can be seen in figure 9. that the maximum tearing forces in the adhesive joint by zero penetration were two times higher than in case of the 2 mm thick plastic sheet. It can be seen that the plastic sheet's thickness is important from the point of view of the strength, because the deformation of the sheet could cause a different stress distribution in the adhesived zone. The higher the deformation, the lower the maximal tearing force. The deformation phenomenon can be observed in the tearing diagrams too. The order between the two applied gluing materials remains the same as in the case of 2 mm thick sheets. With Loctite 496 a two times higher strength was realized as compared with Loctite 454. When the penetration depth was changed to 3 mm the average maximum tearing force increased radically to 456 N and 471 N, due to the bigger surface and due to the changed ratio between pulled and sheared interfaces on the face surface and cylindrical surface of the pin.

Compared to the results in figure 8. laser assisted joining resulted in higher maximum tearing forces too. In case of 0,4 mm penetration, it was 438 N and in case of 3 mm depth, 375 N. These values are below the adhesive joining in case of 5 mm thick sheet. The reason is that the maximal tearing force has an optimum point against penetration because the above mentioned bubble formation hinder the further increase of the tearing force [9].

It can be seen that the adhesive joint shows less than 8% higher strength in the case of the same 5 mm thick sheet as compared with laser joining. However, by applying shape locking geometry pins, the maximum tearing force can be increased until about 900 N in case of 5 mm thick PMMA sheet and steel pin.

From this result, it can be seen that the laser assisted metal and plastic joining technology means an alternative process to adhesive bonding. Furthermore, laser technology does not need any sample preparation like hole drilling or a strict cleaning process, it does not need any additive materials and there isn't any curing time: the joining force forms within few seconds. These beneficial properties make LAMP joining a remarkable alternative process.



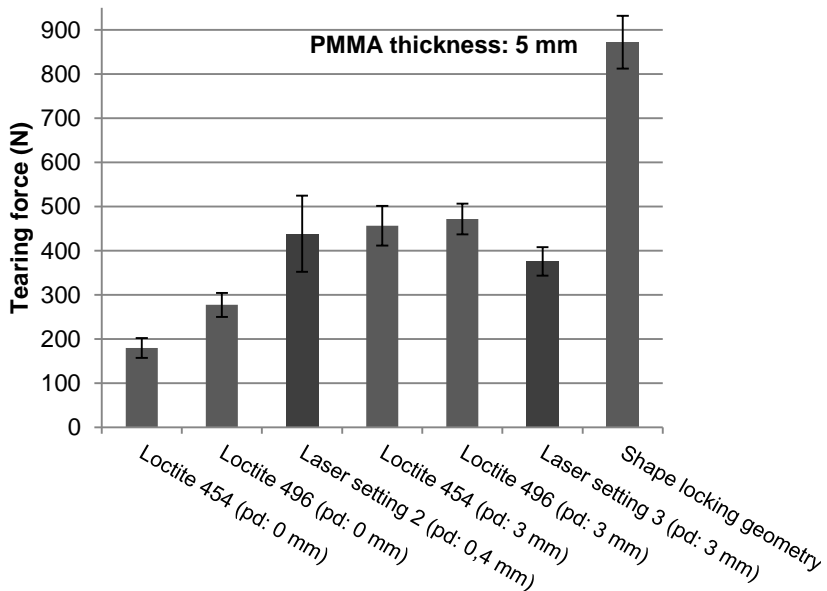

**Fig. 9** Maximal tearing forces in case of different joining process (pd: penetration depth)

#### 4. Conclusions

From the result of this research the following can be concluded:

- pulse mode laser beam allows higher tearing force at the same penetration compared to continuous mode beam: the lower heat input of pulsed mode beam results in less intensive bubble formation;
- contrary to adhesive bonding, in case of laser joining a shrinkage phenomenon can be observed which contributes to the joining strength and enhances the tearing force;
- comparing the two applied adhesives, Loctite 496 ensures a higher strength in every investigated case, but the differences are balanced at the deepest penetration;
- in case of thinner sheets, pulse mode laser joining provides higher tearing forces than adhesive joining;
- laser assisted plastic metal joining is an alternative joining process to adhesive bonding: laser joining is a faster process, as it does not require any pre-treatment and the utilization of any additive material. Therefore further disadvantages of the additive materials are also not be counted with.

#### 5. Acknowledgements

The authors are grateful for the financial support of the OTKA organisation (project number: 109436) and Henkel Hungary Ltd. for providing the adhesives.

### Literature

1. HOLTkamp, J., ROESNER, A., GILLNER, A.: *Advances in hybrid laser joining*. International Journal of Advanced Manufacturing Technology, Vol. 47, pp. 923–930, (2010).
2. KATAYAMA, S., KAWAHITO, Y.: *Laser direct joining of metal and plastic*. Scripta Materialia, Vol. 59, pp. 1247–1250, (2008).
3. LYTVYNENKO, T., GASENKO, L.: *Peculiarities of infrastructure designing for the movement of individual environmental friendly vehicles*. Periodica Polytechnica Transportation Engineering, Vol. 43, No. 2, pp. 81-86 (2015).
4. DOMANOVSKY, H.: *Gas propulsion or e-mobility is the solution on the way of clean and carbon free road transportation?* Periodica Polytechnica Transportation Engineering, Vol. 42, No. 1., pp. 63-72 (2014).
5. CENIGAONAINDIA, A., LIÉBANA, F., LAMIKIZ, A., ECHEGOYEN, Z.: *Novel strategies for laser joining of polyamide and AISI 304*. Physics Procedia, Vol. 39, pp. 92-99, (2012)
6. ROTHEISER, J.: *Joining of Plastics*. Hanser Verlag, München, (1999).
7. KAWAHITO, Y., KATAYAMA, S.: *Innovation of laser direct joining between metal and plastic*. Transactions of JWRI, Vol.39, No. 2, pp. 50, (2010).
8. SULTANA, T., GEORGIEV, G.L., BAIRD, R.J., AUNER, G.W., NEWAZ, G., PATWA, R., HERFURTH, H.J.: *Study of two different thin film coating methods in transmission laser micro-joining of thin Ti-film coated glass and polyimide for biomedical applications*. Journal of the Mechanical Behavior of Biomedical Materials, Vol. 2, pp. 237-242, (2009).
9. BAUERNHUBER, A., MARKOVITS, T.: *Investigating the joining of PMMA plastic to steel by Nd:YAG laser*. Materialové Inžinierstvo-Materials Engineering, Vol. 19 (4), pp. 164-174, (2012).
10. BAUERNHUBER, A., MARKOVITS, T.: *Laser Assisted Joining of Metal Pins and Thin Plastic Sheets*. Physics Procedia, Vol.: 39, pp.: 108-116, (2012).
11. Markovits, T., Bauernhuber, A., Mikula, P.: *Study on the transparency of polymer materials in case of Nd:YAG laser radiation*. Periodica Polytechnica Transportation Engineering, Vol. 41, No. 2., pp. 149-154 (2013).

### Summary

#### Comparison of pulse mode nd:yag laser assisted metal plastic joining with competitive technologies

Andor Bauernhuber, Tamás Markovits

The joining of plastics and metals in order to produce lightweight but high strength parts becomes more and more relevant for modern industry. Bonding different materials was carried so far out primarily by adhesives, however, novel technologies, like laser assisted metal-plastic joining are showing benefits against current technologies. In the course of this study, the authors joined PMMA plastic to structural steel by adhesives and by laser assisted metal-plastic joining, applying continuous mode and pulse mode beam sources as well. Mechanical tests were carried out to compare the different methods, and to be able to position the LAMP joining within the field of joining technologies. Results show clearly the advantages of pulse mode laser transmission joining.